

PROPRIETARY INFORMATION  
COMPANY CONFIDENTIAL

REV.	ECN. NO.	DESCRIPTION	ENG	DATE
A		INITIAL	Knight	1/10/16'

= Dispensing Area

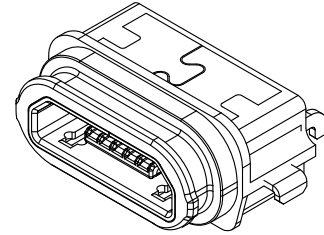
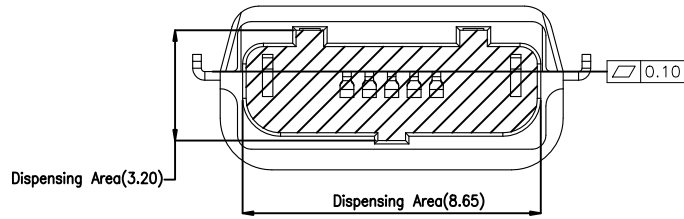

NOTE:  
1. Ingress Protection: IP 67

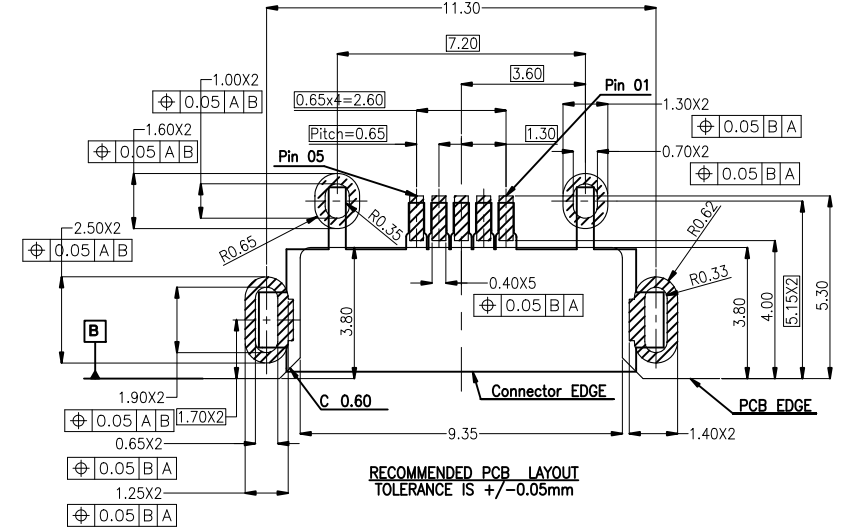
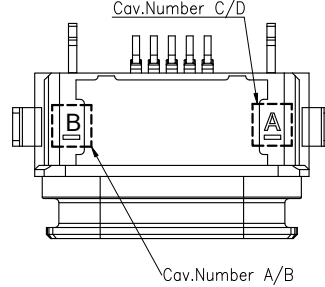
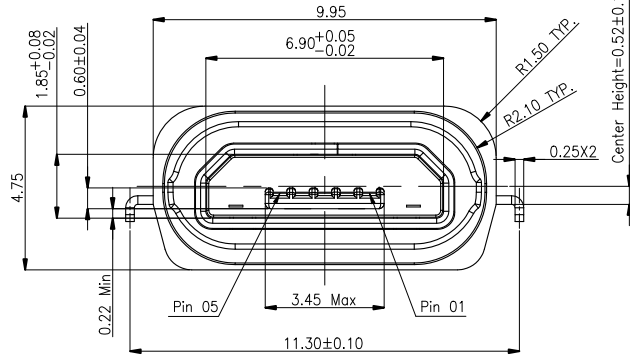
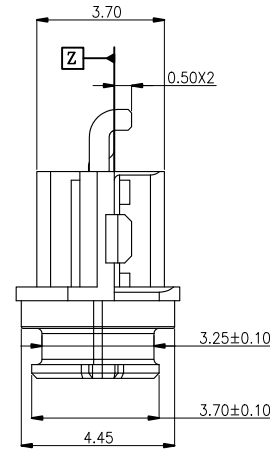
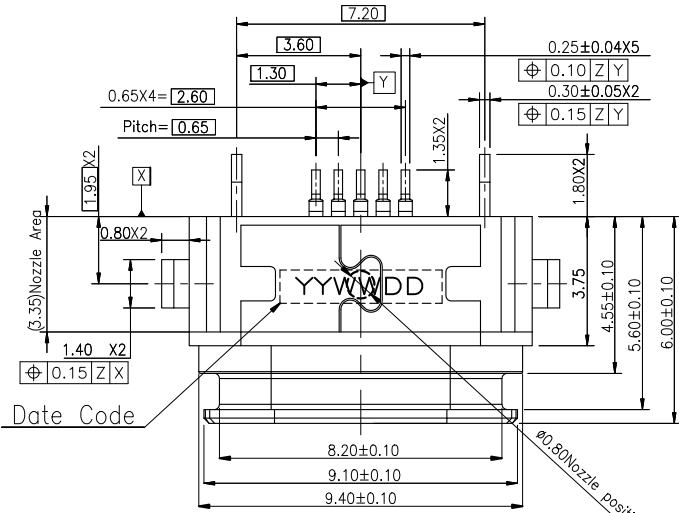

RECOMMENDED PCB LAYOUT  
TOLERANCE IS +/-0.05mm

ITEM	NAME	Q'TY	DESCRIPTION	NOTE
5	SUPPORT	1	SUS, NICKEL 50u" MIN PLATING OVERALL	
4	OUT SIDE SHELL	1	SUS,TIN 40u"MIN PLATING OVER NICKEL 50u" MIN PLATING OVERALL	
3	SHELL	1	SUS, NICKEL 50u" MIN PLATING OVERALL	
2	CONTACT	5	PHOSPHOR BRONZE,GOLD 15u"MIN PLATING ON CONTACT AREA,GOLD 3u" MIN PLATING SOLDER AREA,NICKEL 50u" MIN UNDER PLATING OVERALL	
1	HOUSING	1	PA9T+42%GF	BLACK, UL94 V-0

GENERAL TOLERANCE X±0.50 .X±0.38 .XX±0.25 .XXX±0.15	ANGLE TOLERANCE X°±5.0° .X°±3.0° .XX°±2.0° .XXX°±1.0°	DRAWN <i>hughe</i>	DATE 1/10/16'
MATL SEE BOM	FINISH SEE NOTES	CHECKED	DATE
SCALE N/A	UNIT mm	APPROVED <i>River</i>	DATE 1/10/16'
SHEET 1 OF 2			

 TITLE: WaterProof Micro USB Sinking Type Connector(Reverse)		PART NUMBER: 260-10003-01
SIZE A4	REV. A	