

VIEW 0  
SCALE 3:1

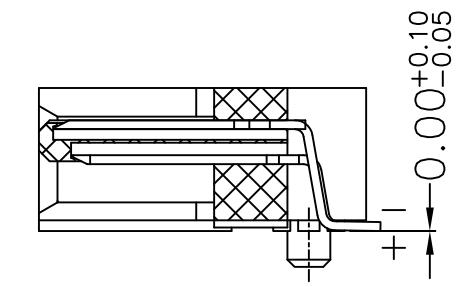

SECT A-A  
SCALE 2:1

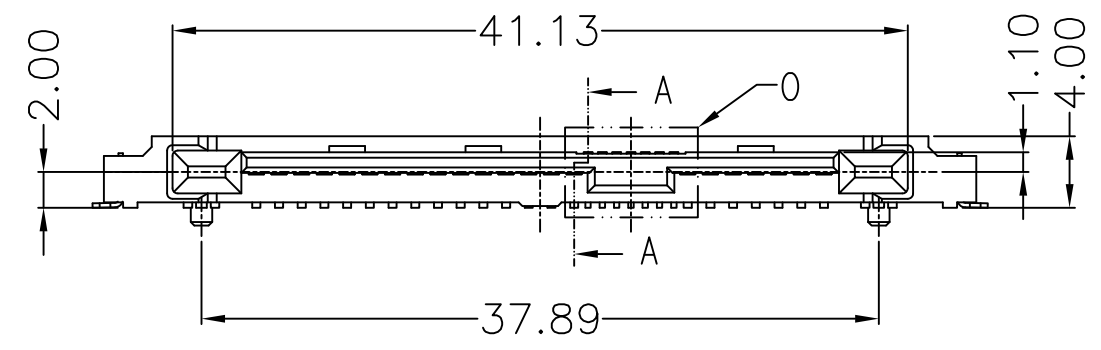
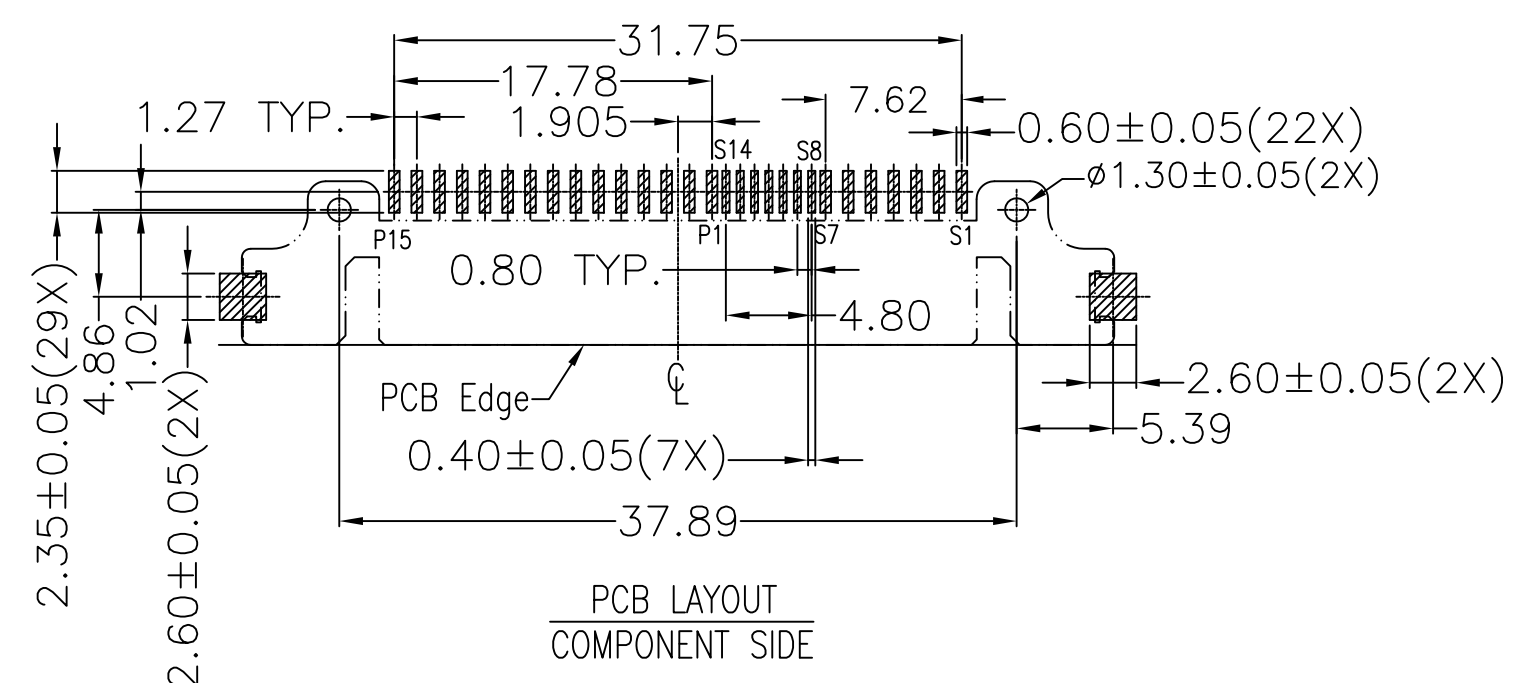
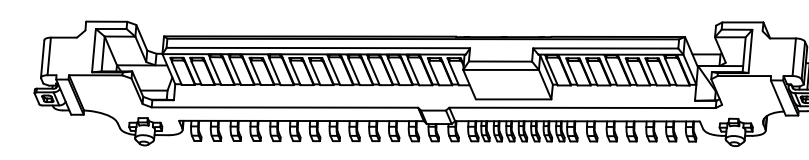
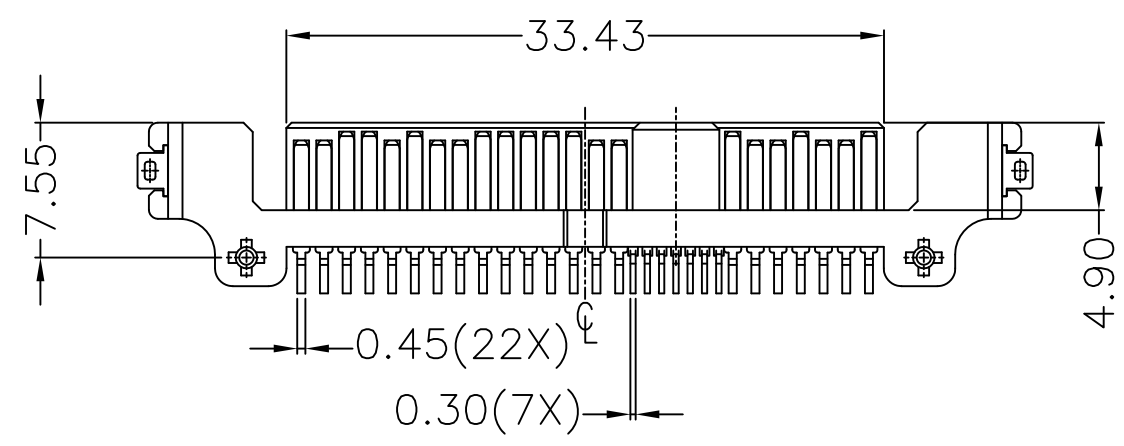

NOTES:

- MATERIAL  
HOUSING: LCP+50%GF, UL 94V-0 RATED, COLOR BLACK  
CONTACT: BRASS  
HARPOON: PHOSPHOR BRONZE
- PLATING  
CONTACT: GOLD 30u" MIN. PLATING ON CONTACT AREA,  
TIN 80u" MIN. PLATING ON SOLDER TAIL,  
NICKEL 30u" MIN. UNDERPLATING OVERALL  
HARPOON: TIN 80u" MIN. PLATING OVER NICKEL 30u" MIN.
- MECHANICAL  
INSERTION FORCE: 25N MAX.  
WITHDRAWAL FORCE: 5N MIN.  
DURABILITY: 500 CYCLES
- ELECTRICAL SPECIFICATION  
CURRENT RATING: 1.5 AMPERE PER CONTACT  
CONTACT RESISTANCE: 30 mΩ MAX.  
INSULATION RESISTANCE: 1000 MΩ MIN.  
DIELECTRIC WITHSTANDING VOLTAGE: 500 VAC
- OPERATING TEMPERATURE: 0°C TO +55°C
- RoHS COMPLIANT

ORDER INFORMATION

SASR - 11 29 - B K 6 0 T 1F  
① ② ③ ④ ⑤ ⑥ ⑦ ⑧

- CONNECTOR:  
SASR: SAS R/A CONNECTOR
- TYPE:  
11: SAS 29P RIGHT ANGLE SMT MALE
- POSITIONS:  
29: 29 POSITIONS
- INSULATOR MATERIAL:  
B: LCP
- INSULATOR COLOR:  
K: BLACK
- CONTACT PLATING:  
6: GOLD 30u" MIN.
- SHIELD PLATING:  
0: WITHOUT SHIELD
- PACKING:  
T: TRAY

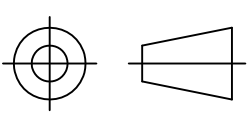
TOLERANCE				TITLE:				
LINEAR	ANGLES			SAS 29P RIGHT ANGLE SMT MALE				
X. ±	X° ± 3°	7F, No. 191, Sec. 2 Chung-Yang Rd., Tu-Cheng City Taipei Hsien, Taiwan		PART NO. SASR-1129-BK60T1F				
.X ± 0.38	.X° ±			DWG NO. GTi10-20200				
.XX ± 0.25	.XX° ±	APPD:	MAT'L:		UNITS	SCALE	SHEET	REV
.XXX ± 0.20	.XXX° ±	CHKD:	FINISH:		MM	NONE	1 OF 1	A
		DRWN: Jeff	Q'TY:					

A	FIRST RELEASE	Jeff	11/26/10'
REV	ECN NO.	NAME	DATE